

FACTORYLUX®

MULTI OUTLET | 7 WAY

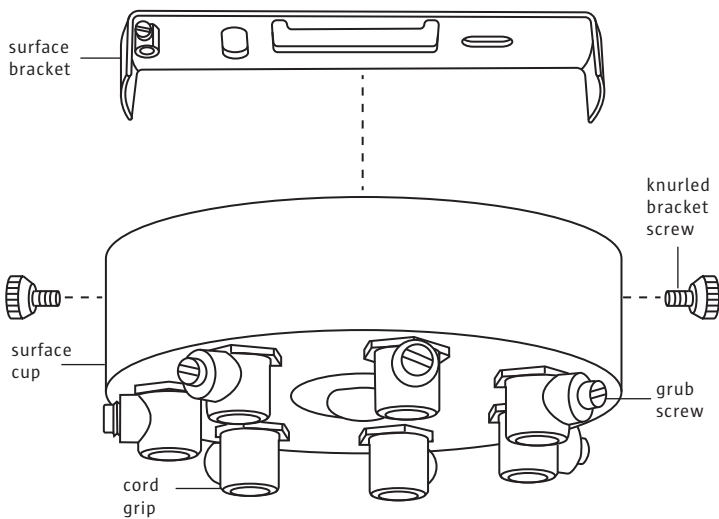

WHAT'S INCLUDED

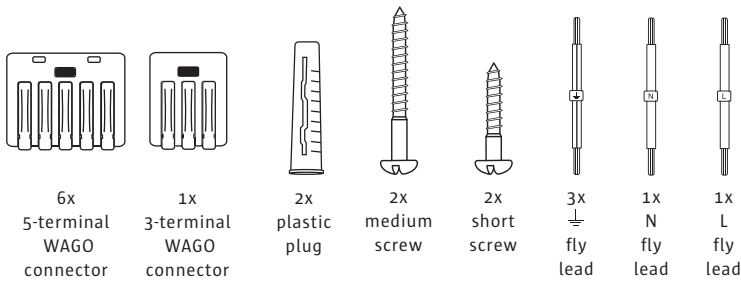

YOUR PRODUCT

Thank you for purchasing this Factorylux product. It has been designed and hand built in the UK to give you many years of reliable service. Please read these user instructions carefully. All user instructions available to download at factorylux.com

WARNING

- Installation by a competent person, in accordance with current wiring and building regs. Find an NICEIC registered contractor at factorylux.com
- For indoor use only
- Shut off power to the circuit before installation
- Cord grip max weight load 5kg
- Always consider the total weight load when installing and suspending your light
- Always use fixings appropriate for the mounting surface (screws supplied may not be suitable)
- Ensure grub screws are secure - terminals must be relieved from strain and twisting
- Ensure luminaire cord is min 0.75mm CSA and double insulated
- Bathroom installation by authorised contractor only

HANDLING & CLEANING

WARNING: Shut off power and allow to cool

- Wipe gently with a dry, soft, cotton cloth
- Cleaning products, scratching, abrasion, damp, oils, liquids etc may have a detrimental effect

TROUBLESHOOTING

No user serviceable parts. In the event of fault or damage contact our tech department via factorylux.com

STAY UP TO DATE

We post regular design and product information via social media and our blog. You can also contact us via instant support, twitter or email hello@factorylux.com



FACTORYLUX®

USER INSTRUCTIONS

TOOLS REQUIRED

- Drill + 6mm masonry bit
- 6mm + 4mm flat head screwdrivers

INSTALLATION NOTES

- Surface cup is designed to be fixed to a solid horizontal surface, using the bracket and appropriate fixings
- Surface cup is not designed to house an electrical connection
- A suitable, non-combustible enclosure in an existing or new ceiling void is required to make a connection

INSTALLATION (MASONRY SURFACE)

WARNING: Light fitting to be insulated and earthed in accordance with current building and wiring regs

1. Drill 2 x 6mm holes x 30mm deep at 50.8mm centre spacings
2. Insert plastic plugs into holes
3. Use 6mm screwdriver and supplied medium screws to fix bracket to horizontal surface (alternatively, use supplied short screws only to fix luminaire to timber surface)
4. Feed luminaire cables through cord grips and tighten grub screws with 4mm screwdriver **CAUTION:** WAGO terminals should be relieved from strain or twisting
5. Use supplied WAGO connectors and fly leads to make L, N and \perp connections (as per 'multi outlet wiring diagram'):
 - Flip integrated orange lever up to open position
 - Insert exposed conductor to stopping point
 - Return lever to closed position
6. Secure surface cup to bracket using knurled bracket screws, feeding the WAGO connectors into ceiling void as necessary

MULTI OUTLET WIRING DIAGRAM

WARNING: Ensure no loose copper strands

