

FACTORYLUX[®]

GoOutside™

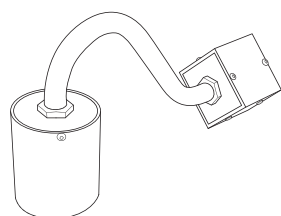

WHAT'S INCLUDED

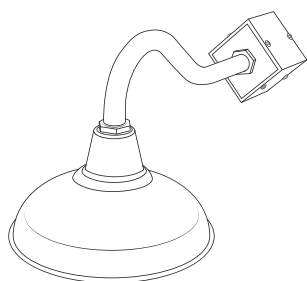
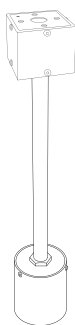
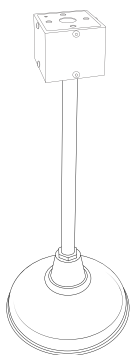
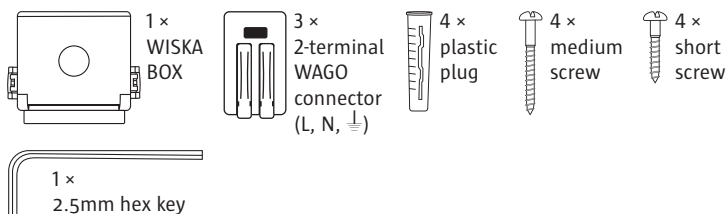

TOOLS REQUIRED

- Drill + 6mm masonry drill bit
- 6mm + 4mm + 3mm flat head screwdrivers

INSTALLATION NOTES

- Wall lights to be mounted on vertical surface only, with light source facing down. **CAUTION:** Failure to install correctly may cause moisture to collect
- Pendant lights to be mounted on horizontal surface only

INSTALLATION

NOTE: Wall light mounting box to be mounted at 45°

1. Drill 4 x 6mm holes x 30mm deep at 50.8 mm centre spacings
2. Insert plastic plugs into holes
3. Remove 4 x M4 socket screws to detach back plate using supplied 2.5mm hex key
4. Use screwdriver and supplied medium screws to fix back plate to the surface (alternatively, use supplied short screws only to fix to a timber surface)
5. Use supplied WAGO connectors to make L, N and ⚡ connections
 - Flip integrated orange lever up to open position
 - Insert exposed conductor to stopping point
 - Return lever to closed position
6. Place L + N WAGO connectors inside WISKA gel box and ensure it closes fully.
7. Replace 4 x M4 socket screws to secure box on back plate

YOUR PRODUCT

Thank you for purchasing this Factorylux product. It has been designed and hand built in the UK to give you many years of reliable service. Please read these user instructions carefully. All user instructions available to download at factorylux.com

WARNING

- Installation by a competent person, in accordance with current building and wiring regs. Find an NICEIC registered contractor at factorylux.com
- Class 1
- IP65; failure to install correctly could affect IP rating
- Bathroom installation by authorised contractor only
- Shut off power to the circuit before installation
- Max ambient temperature 35°C
- Ensure WISKA box is closed fully with 2 WAGOs inside
- Always use fixings appropriate for the mounting surface (screws supplied may not be suitable)
- Ensure light source does not contact surfaces

TROUBLESHOOTING

No user serviceable parts. If light source replacement is required or in the event of failure, fault or damage shut off power and contact our technical department via factorylux.com

HANDLING & CLEANING

WARNING: Shut off power and allow to cool

- Wipe gently with a dry, soft, cotton cloth
- Cleaning products, scratching, abrasion, damp, oils, liquids etc may have a detrimental effect
- Metal Shades (only) can be polished using metal polish

WIRING DIAGRAM

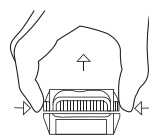
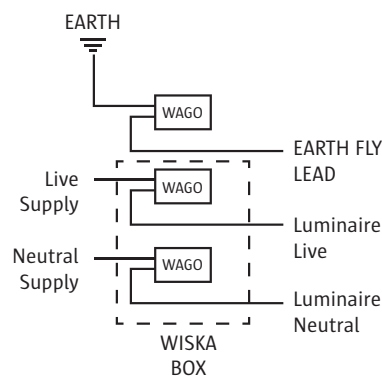

Secured & protected connection in 3 steps

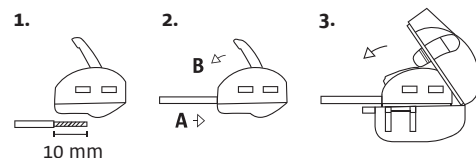

- Press to open
- Insert clips into side buckle to secure

DID YOU KNOW...?

You can find out when and by whom your product was made, tested and certified to BS EN 60598 / BS 4533. Search the unique batch code (found on label) at factorylux.com. You'll even find out what was hot news in the Hebden Bridge Times the day your product was made

STAY UP TO DATE

We post regular design and product information via social media and our blog. You can also contact us via instant support or email support@factorylux.com



1. VALENTINA PENDANT

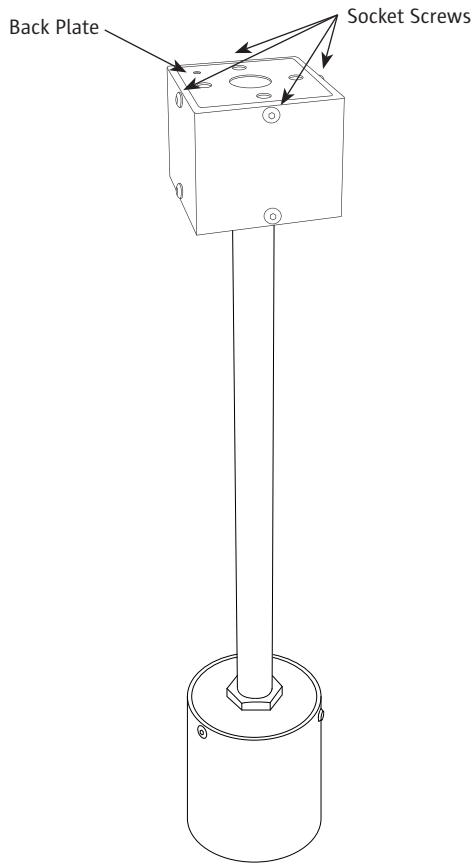

2. KAY PENDANT

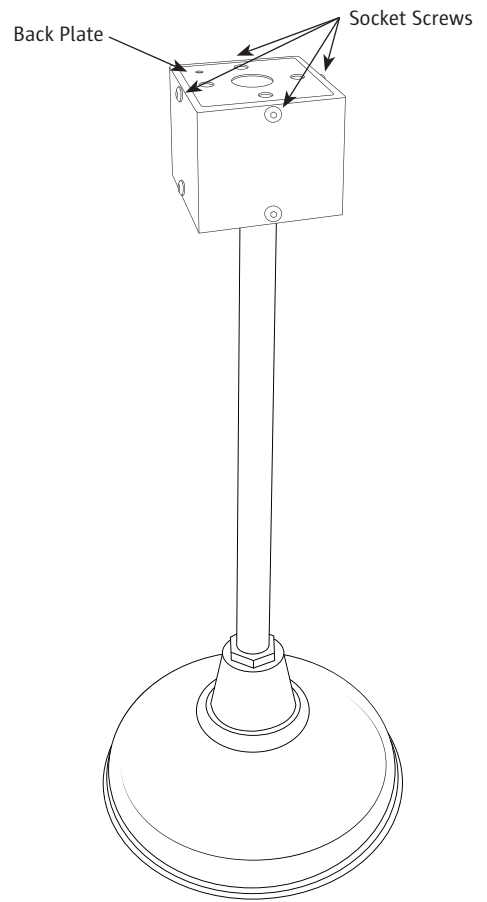

3. JUNKO WALL LIGHT

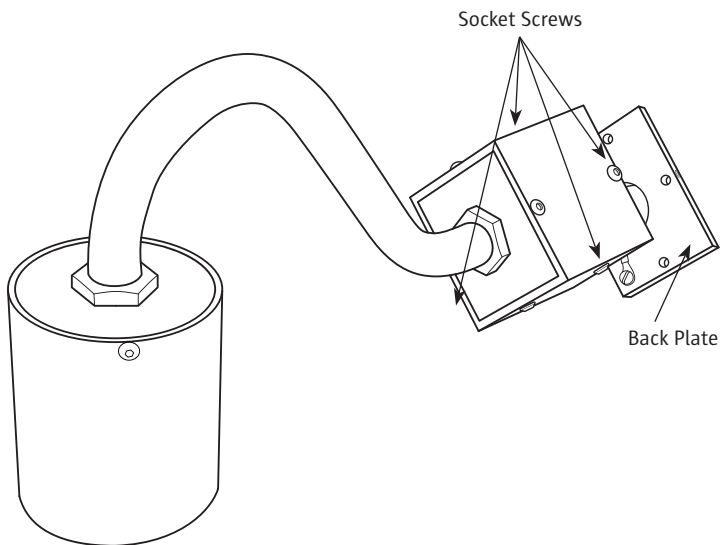

4. KATIA WALL LIGHT

