

FACTORYLUX[®]

13A FUSED PLUG

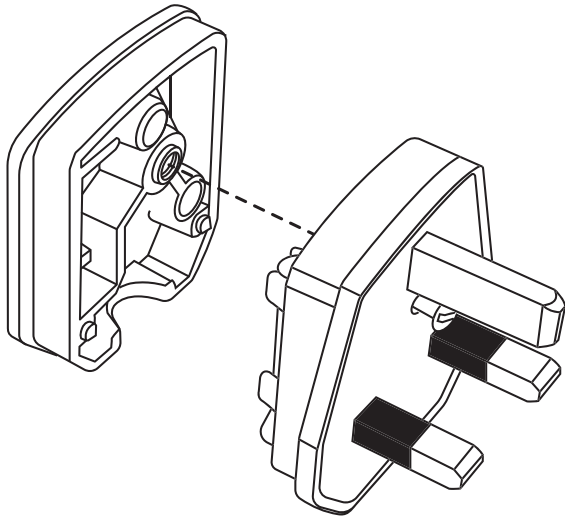

Bakelite | white S150200 | black S150100

WHAT'S INCLUDED

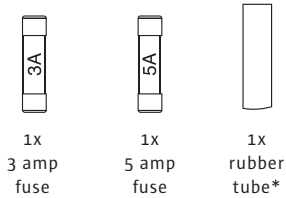

*only compatible with fabric lighting cable

YOUR PRODUCT

Thank you for purchasing this Factorylux product. It has been designed to give you many years of reliable service. Please read these user instructions carefully. All user instructions available to download at factorylux.com

WARNING

- Installation by a competent person only. If in doubt, find an NICEIC registered contractor at factorylux.com
- Not suitable for use in wet or damp conditions
- Supplied fitted with 13 amp fuse
- Do not exceed maximum allowable load
- Always use correct fuse to suit appliance and cable
- Must be earthed
- Only compatible with 3 core cable
- Ensure cable is secure in cord grip - terminals must be relieved from strain and twisting
- Ensure cables are secured in terminal channels

TROUBLESHOOTING

No user serviceable parts. In the event of failure, fault or damage shut off power and contact our technical department via factorylux.com

STAY UP TO DATE

We post regular design and product information via social media and our blog. You can also contact us via instant support, twitter or email hello@factorylux.com



VARIANTS

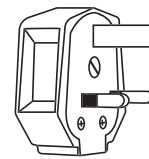

heavy duty
black S151700
orange S151800
white S151900

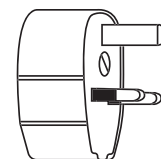

red hospital
S152000

FACTORYLUX[®]

USER INSTRUCTIONS

TOOLS REQUIRED

- Screwdriver - dependant on plug
- Insulation strippers
- Small sharp scissors

INSTALLATION NOTES

- Compatible with Factorylux lighting and power cable
- If using fabric cable, we recommend using suitable heat shrink to secure fabric sleeve (supplied rubber tube can be used on Factorylux lighting cable)
- We recommend using ferrules with crimping pliers to crimp exposed stranded conductors. It's simpler, neater and safer

INSTALLATION

CAUTION: Reference correct 'wiring diagram' for each plug

1. Remove required length of fabric sleeve from cable using scissors
CAUTION: Take care not to damage insulation
2. Cover frayed fabric with supplied rubber tube (lighting cable only)
3. Prepare cores (as per appropriate 'wiring diagram')
4. Terminate N, L and \perp in sequence
5. Secure cable in cord grip **CAUTION:** Terminals should be relieved from strain or twisting
6. Fit correct sized fuse
7. Replace and secure cover

HANDLING & CLEANING

WARNING: Shut off power

- Remove all plugs from sockets
- Wipe gently with a dry, soft, cotton cloth

WIRING DIAGRAMS

N = blue or black
L = brown or red
 \perp = green/yellow or green

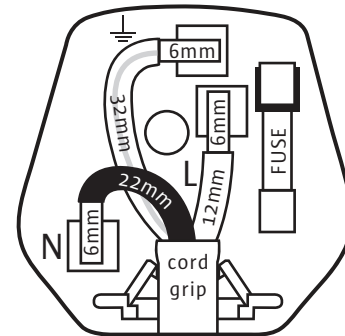

Bakelite

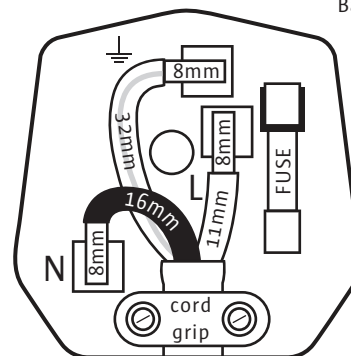

heavy duty

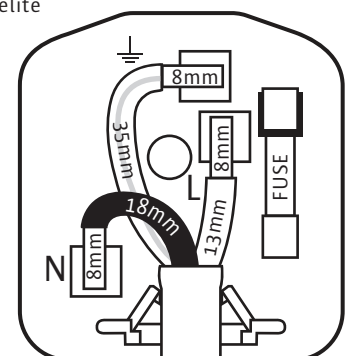

hospital

Designed, made & tested to BS 1363
Revision 1603

